

GORBEL
A CLASS ABOVE



Lifting Systems Inc.

8121 Saddleback Place
Maineville, OH 45039
Phone: (513) 677-1770
Fax: (866) 313-5501

CRANES

WORK STATION BRIDGE CRANES & MONORAILS

CAPACITIES:	Up to 4000 lbs.
CONFIGURATIONS:	Free Standing and Ceiling Mounted
TRACK MATERIALS:	Steel, Aluminum & Stainless Steel
PRODUCTIVITY:	Average 28% increase

GORBEL 1000 LBS. CAPACITY
PERMANENT, NEW YORK, U.S.A. DO NOT EXCEED RATED CAPACITY

GORBEL 1000 LBS. CAPACITY
PERMANENT, NEW YORK, U.S.A. DO NOT EXCEED RATED CAPACITY

Bridgport **CNC**



GORBEL: A CLASS ABOVE

- Productivity
- Safety
- Ease of installation and relocation
- Modular designs
- Designs, capacities, and spans
- Specially engineered systems

Gorbel's Crane Technology and Ergonomic Lifting products are the handling equipment you need to get the job done. Since 1977, Gorbel has specialized in overhead material handling solutions, earning a reputation for providing our customers with the highest quality products and the highest performance.

Our product line has grown to include products that improve safety and productivity in a variety of applications and industries, handling loads from 50 lbs to 50 ton.

TABLE OF CONTENTS

Why choose Gorbel?.....	2
Work station cranes and monorails	3
Benefits of enclosed track	4
Track profiles.....	5
How to apply work station cranes	6
Case study	7
Work station crane components	8
Case study	11
Custom crane components	14
Options when using multiple bridges	14
Custom crane configurations	16
Case study	19
Installation guidelines	20



Lifting Systems ..
8121 Saddleback Place
Maineville, OH 45039
Phone: (513) 677-1770
Fax: (866) 313-5501

WHY CHOOSE GORBEL?

INDUSTRY'S BEST WARRANTY

We are proud to offer a ten year (20,000 hour) warranty on manually operated crane systems, including wheel wear. With this warranty, our customers are guaranteed years of quality, dependable service.

QUICK SHIP PROGRAMS

Gorbel offers a 5-Day Quick Ship program which means that most cranes and most components can ship in five working days. Fast, reliable, on time shipments are just one of many ways Gorbel is working with our customers to make it easier to purchase our products. Optional two and three day shipments are also available at a premium.

"IF IT'S LATE, WE PAY THE FREIGHT"

With this optional program, if we don't have an order ready to ship on or before the scheduled ship date, we will pay the freight for the order. Contact your local Gorbel® dealer for details.

RELIABILITY

For over 15 years, we've had an industry leading on-time shipping percentage. We're proud that our customers can rely on us to ship their orders on time, keeping to their installation schedules. No other manufacturer in the industry can offer five day shipping and our industry leading on-time rate.

EASE OF INSTALLATION AND RELOCATION

Gorbel's pre-engineered modular kit designs permit easy expansion and relocation. Runway lengths can be easily expanded by adding runway sections, free standing support assemblies, and additional bridges as needed.

MULTIPLE SHIPPING POINTS

With manufacturing facilities in Fishers, New York; Pell City, Alabama; and Tianjin, China, we are able to offer multiple shipping points, decreasing shipping costs to our customers.

EXTENSIVE DEALER NETWORK

Our network of authorized dealers extends across North America and many countries internationally, making it easier for a trained local material handling sales consultant to provide the best solution for your needs.

CUSTOMER SERVICE SUPPORT

Our Customer Service Representatives go through a rigorous training period on our products and their proper application so they are prepared to handle even the toughest application questions.



Lifting Systems ...

8121 Saddleback Place
Maineville, OH 45039
Phone: (513) 677-1770
Fax: (866) 313-5501

WORK STATION CRANES AND MONORAILS

Bridge cranes cover rectangular work areas, while monorail systems can be used to move loads along a linear path, cover various work area shapes, or to link work areas together. Work station bridge cranes and monorails can be used individually or can be readily adapted for more sophisticated applications by the addition of extra monorail tracks, curves, and transfers that can be easily configured into a total system.

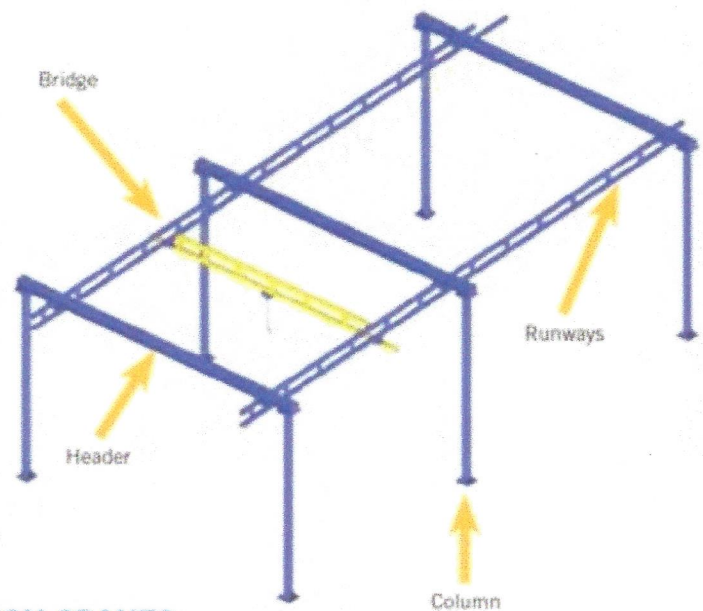

WORK STATION CRANES

Bridge: The bridge is the only part of the work station crane in motion. It supports the lifting device, and facilitates movement of your load along the X and Y axis. Bridges can be as long as 34', and are available in steel or aluminum.

Runways: The bridge's end trucks ride within the track of the crane's runways, which determine the overall coverage area of your work station crane. The track used for runways can be spliced together to span any distance.

Column (free standing only): The columns are the "legs" of a freestanding work station crane, and are bolted to the floor while supporting the columns and runways. The distance between columns is determined by your crane's overall capacity and the selected track type.

Header (free standing only): The work station crane system's header is made of back-to-back "C" channel, which allows for easy connections to the runway hanger support hardware.

MONORAILS

The Solution for True Linear Movement

Gorbel® Work Station Crane Systems can be readily adapted for more sophisticated applications by the addition of extra tracks, curves, switches, and interlocks (transfers) that can be easily integrated into a total system. The pre-engineered modular designs offer the ultimate in flexibility, in layout, and in design for your manufacturing facility.

Monorail Curve

The monorail curve is a section of track that is rolled to provide a 90° curve. The curved sections have a straight section which projects beyond the curve. The curve needs to be supported with three or four hangers, depending on track series.

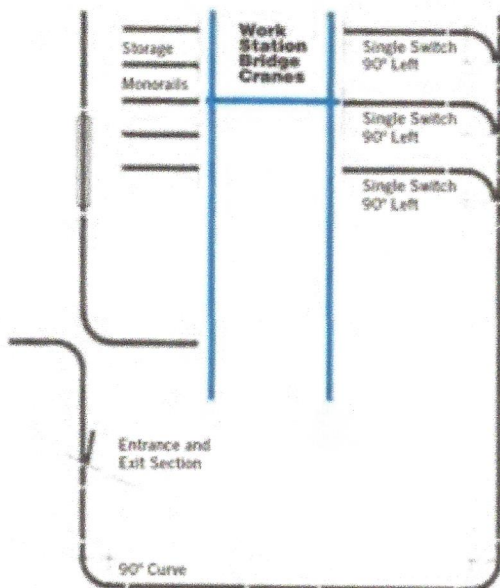

Sample system of work station crane supplemented with monorails.

Monorail Curve



8121 Saddleback Place
Maineville, OH 45039
Phone: (513) 677-1770
Fax: (866) 313-5501

THE RIGHT TRACK MAKES THE DIFFERENCE

WHY BUY ENCLOSED TRACK?

Gorbel's enclosed track design gives you easy movement and long life. Gorbel's steel and aluminum work station crane systems use enclosed track that is both strong and lightweight. The 2° taper of the running flange helps to center wheels in the track and prevents debris from settling on the rolling surface. This allows for smooth, effortless movement of trolleys and end trucks.

MAJOR ADVANTAGES:

- Enclosed track cranes are up to three times easier to move than traditional bridge cranes
- The design protects the rolling surface from the build-up of dirt and dust, making the wheels easier to move
- The smooth running surface means lower rolling resistance
- The low profile of the steel track allows the system to be installed where headroom is a problem.
- The low track weight reduces operator push-pull forces
- Long spans allow systems to be installed where support assemblies are infrequent (up to 30 feet with steel truss design). This reduces the possibility of the support columns interfering with the work cell layout
- Four distinct sizes of track—250, 500, 1000, and 2000 series—enable you to keep bridge weights and costs to a minimum

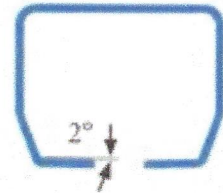

Basic Specifications	
Capacities	To 4000 lbs.
Std. bridge lengths	To 34'
Std. runway lengths	To 124'
Std. support distances	20', 25', 30'

WHY CHOOSE GORBEL'S RIGID RUNWAY SYSTEMS OVER ARTICULATING RUNWAYS

EASY MOVEMENT AND PRECISE LOAD POSITIONING

Gorbel® Work Station Bridge Cranes are installed so that the runways are rigid, allowing no movement laterally or longitudinally. In addition, Gorbel's floating end trucks with horizontal wheels prevent binding by accommodating any imperfections in how parallel the runways were installed. The combination of these design features results in unmatched ease of positioning and movement. The bridge travels smoothly down the runways, and movement is unvarying along the way, no matter where a load is positioned on the bridge. This allows superior load positioning.

Another advantage of rigid runways is that trussed track runways double as stringers between support columns. This eliminates the need for expensive intermediate support stringers, and it lowers overall installation costs.



Lifting Systems ...

8121 Saddleback Place
Maineville, OH 45039
Phone: (513) 677-1770
Fax: (866) 313-5501

TRACK PROFILES

Whether your application requires long spans between supports or making the most of limited headroom, Gorbelt offers track profiles that create opportunities to customize the perfect solution.

PLAIN STEEL TRACK

For use where frequent support points are available or where maximum headroom is required. The standard cold-rolled steel track profile offers a low-weight to high-strength ratio.

Maximum Support Distance	Lifting Capacity
6'	250-4000 lbs.

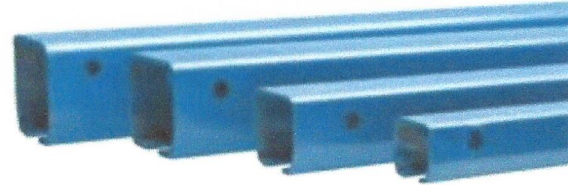

TRUSSED STEEL TRACK

Permits longer spans when frequent support points are not available, giving you more flexibility in crane layout. The trussed series uses the plain steel track profile but is enhanced for longer spans via a built-up truss design. This design increases the span, which decreases the need for frequent hangers. Long spans translate into fewer runway support points, longer bridge lengths, and free-standing capabilities, just another reason why Gorbelt Work Station Cranes are among the most versatile to apply and easiest to install in the industry.

Maximum Support Distance	Lifting Capacity
GLCS - 20', GLCSL - 25', GLCSLX - 30'	250-4000 lbs.

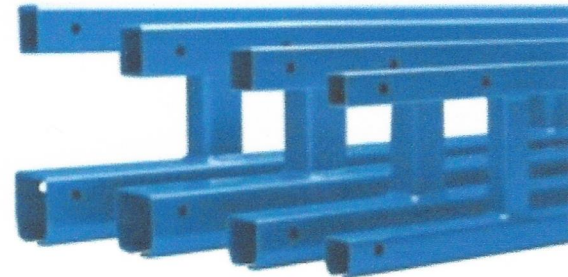

ALUMINUM TRACK

For use where lower bridge weight and easier movement are required. The patented shape of Gorbelt's aluminum enclosed track provides for low weight, unparalleled spanning capability and effortless movement. Weighing as much as 44% less than trussed steel track results in easier movement, which makes for safe, productive, ergonomic work cells. Runway spans up to 20 feet and bridge lengths up to 34 feet meet a wide range of applications.

Maximum Support Distance	Lifting Capacity
20'	150-2000 lbs.

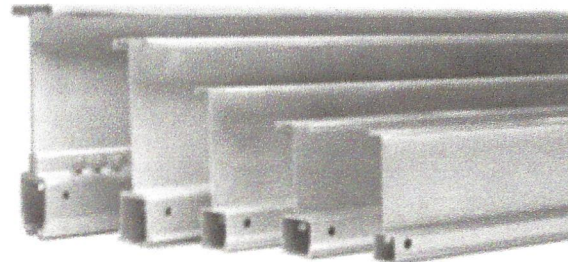

Lifting Systems
8121 Saddleback Place
Maineville, OH 45039
Phone: (513) 677-1770
Fax: (866) 313 5501

HOW TO APPLY WORK STATION CRANES

These questions and answers can help you determine which type of overhead work station crane best meets your needs.



SHOULD IT BE FREE STANDING OR CEILING MOUNTED?

Free standing floor supported systems do not put stress on the building's overhead structure. Installation is usually more straightforward, and these cranes are also easier to relocate in the future. Free standing systems require a reinforced concrete floor of at least 6 inches.

With ceiling mounted systems, supporting steel does not interfere with the handling operation. Ceiling mounted systems require a building with an adequate overhead structure to hang the crane.

WHAT CAPACITY, BRIDGE LENGTH, AND HEIGHT DO I NEED?

The general rule is "less is more".

Keep capacities to a minimum—Gorbel Work Station Cranes are designed with an adequate safety factor. If you "over-buy" capacity, the operator will need to move extra bridge dead weight, which would not be a good ergonomic solution.

Keep bridge lengths to a minimum—The less dead weight an operator has to move, the better. Short bridge lengths are better for higher cycle production areas. Longer bridges are acceptable for lower production cycle or maintenance areas.

Keep bridge heights to a minimum—Keeping the height less than 14' is desirable because it makes it easier to control and position the load.

SHOULD THE CRANE BE MANUAL OR MOTORIZED?

Ease of movement and light weight are key features of enclosed track work station crane systems. In fact, manual work station cranes do the job faster than motorized cranes.

If the operator cannot control the load throughout the operation (for instance, over a vat, a pit, or other inaccessible area), then the crane should be motorized.

WHAT IS MEANT BY RATED CAPACITY?

The rated capacity is the live load that can be lifted by the crane system. The design load for the crane system is based on the rated capacity plus 15% for the weight of the hoist and trolley (capacity x 1.15) and an additional 25% for impact (capacity x 1.25) for a total design of capacity x 1.4 (Note: 25% impact factor is good for hoist speeds up to 50 f.p.m.).

For example, a 1000 lb Gorbel crane allows you to pick up a 1000 lb load, provided the hoist weighs 150 lb or less and the hoist speed is less than 50 feet per minute.

Design load for deflection calculations is based on the rated capacity plus 15% for the weight of the hoist and trolley (capacity x 1.5). Under no conditions should the crane be loaded beyond its rated capacity. Gorbel work station cranes meet or exceed the ANSI B30.11 specifications for underhung bridge cranes.

WORK STATION CRANE HELPS DOUBLE PRODUCTIVITY

"One operator is able to do 30 cycles per shift, where before we may have only done 15."

Professional Fabricators, Inc. is a small fabrication shop in suburban Wisconsin which cuts and forms sheet metal for radiators, generators and other electrical applications. The sheet metal being handled typically measures between 4 and 5 feet wide by 8 to 10 feet long, and is between $\frac{3}{4}$ to 1 inch thick, often weighing as much as 650 pounds.

When the shop received two new laser cutting machines for its fabricating, it began searching for the best way to lift the sheet metal onto the cutting machines. It required the raw sheets to be lifted from the stack where they are delivered, turned to a machine directly behind the operator, and precisely placed on the laser cutting table.

Initially, the company tried moving the sheet metal onto the machine with a fork lift. With this method, placement was too difficult and the fork lifts were bumping into the machines. The company also tried using two operators to lift and position the sheets onto the machine. While positioning was more accurate than with the fork lift, the doubled cost of labor paired with safety hazards that come with such heavy, sharp material eliminated that option.

"Moving the sheet metal onto the cutting machines was too great of an injury risk to ignore," said Brian Moeller, Manufacturing Engineer for Professional Fabricators. "We had a lost time injury, and within a week recognized the need for something to help move the metal,"

Among the options for a solution was automating the process. While it would have reduced injuries, the cost of the automation was far too high for the shop to invest in.

The company decided on two Gorbels free-standing work station cranes with 1 ton capacity aluminum bridges, one for each cell with a laser cutting machine. A one-ton capacity chain hoist with a vacuum end effector grips the sheet metal, and one operator is able to effortlessly move the heavy sheet metal from the delivered stack and place it on the cutting table.

"The Gorbels system has worked out very well," said Moeller. "One operator is able to do 30 cycles per shift now, where before we may have only done 15. Plus, there have been no injuries. Operators are very happy and there was no hesitation to use the Gorbels cranes. They aren't complicated and don't slow them down, so they use them."



SEE VIDEO OF THIS APPLICATION!

See this Gorbels solution in action by scanning the QR code below.



"Operators are very happy and there was no hesitation to use the Gorbels cranes."

See this and many more work station crane case studies at www.gorbels.com/solutions/casestudies

ANATOMY OF A WORK STATION CRANE

The industry's best work station cranes are built using components that are engineered, tested and crafted to provide smooth movement for years.



1 HOIST TROLLEY

Gorbel's hoist trolleys provide the connection between the lifting device and the bridge. The trolleys are designed for effortless movement along the bridge. The stamped body fits most rigid hook or eye lifting devices.

Wheels are tapered to match the 2° taper of the track. This reduces rolling resistance and wheel wear. Wheels contain ball bearings that are sealed and lubricated for life.

Trolleys are designed to operate in temperatures from +5°F to +200°F.

All trolleys meet or exceed the ANSI B30.11 specification for underhung bridge cranes.



Standard End Truck

2 END TRUCKS

Gorbel® end trucks provide the connection between the bridge and runways. They are designed for effortless movement along the runway.

Wheels are tapered to match the 2° taper of the track, which reduces rolling resistance and wheel wear. Wheels contain ball bearings that are sealed and lubricated for life.

Two horizontal wheels center the end truck within the runway which prevents binding of the bridge. As a result, the position of the load on the bridge has little effect on the amount of force needed to move the bridge along the runway.

Any slight runway track misalignment is taken up by the bridge floating in one end truck, while the other end truck is firmly clamped to the bridge.

All end trucks meet or exceed the ANSI B30.11 specification for underhung bridge cranes.



Aluminum End Truck

EXTENDED END TRUCKS

The extended end truck is designed for longer bridge lengths, and helps evenly distribute the weight of the load to maintain easy bridge movement and prevent binding.



Extended End Truck



Lifting Systems ...

8121 Saddleback Place
Maineville, OH 45039
Phone: (513) 677-1770
Fax: (866) 313-5501



1. HOIST TROLLEY
2. END TRUCK
3. FESTOON GLIDER
4. FESTOON TROLLEY
5. FESTOON CLAMP
6. END STOP BUMPER
7. UNIVERSAL BUMPER
(not shown)
8. STACK SECTION
9. FLAT CABLE/AIR HOSE
10. HANGER ASSEMBLY

 **Lifting Systems** ...
8121 Saddleback Place
Maineville, OH 45039
Phone: (513) 677-1770
Fax: (866) 313-5501

FESTOONING: FLAT CABLE, AIR HOSE, AND CONDUCTOR BAR



FESTOON GLIDERS

Festoon gliders are used to support flat cable along the runway and bridge, and they are standard on steel runways of 63 feet or less. No tools are required to attach the festooning to the gliders.



FESTOON TROLLEYS

Gorbel® festoon trolleys (optional) are used to support flat cable or air hose along the runway or bridge. The trolleys have four wheels and a pivoting festoon saddle support. They are ideally suited for long runways (greater than 63 feet) or with round cable or air hose. With runways greater than 63 feet or with an all aluminum system, festoon trolleys are standard. Special festoon trolleys for vacuum hose are also available.



FESTOON CLAMPS

Festoon clamps anchor the festooning at the start of the runway and bridge. They also prevent the festoon gliders from exiting the track and they can provide a redundant stop for the end trucks and trolley. Festoon tow clamps are also available for systems with standard end trucks.

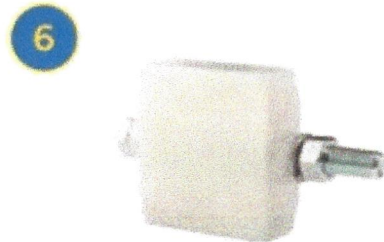

END STOP BUMPERS

High-impact molded end stop bumpers are provided on all runways and bridges to prevent the end trucks and trolley from exiting the track. The bumpers are bolted to the track to physically limit the travel of the end truck and trolley.

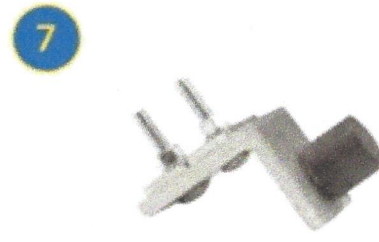

UNIVERSAL BUMPERS

(not shown on pg. 9)
A universal bumper can be used as an intermediate end stop, primarily for zoning purposes.

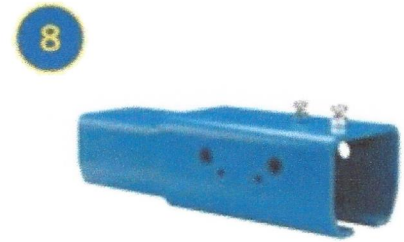

STACK SECTIONS

A stack section at one end of a runway serves as an extension that allows festoon carriers to be stored on the end of the runway without reducing crane coverage.

9 FLAT CABLE AND/OR AIR HOSE

A flat cable festooning system is included in all Gorbel® Work Station Bridge Cranes. Plenty of cable is provided for 3 foot loops on the runway and 1 foot 6 inch loops on the bridge. Optional air hose is also available and is supported by optional festoon trolleys. Gorbel® Work Station Cranes can utilize optional conductor bar electrification, but this results in an increase up to 40% of the amount of effort required to move the system.

LIFTING SOLUTION REDUCES EMPLOYEE BACK INJURIES

"With this Gorbel workstation crane, there have been no injuries...biggest success."

Green Bay Packaging is a pulp and paper manufacturer using 100% recycled materials to produce a wide variety of paperboard packaging. The large rolls are slit and sized based on customer demand, and moved to a work cell in stacks where they are loaded onto skids for final shipping. The size of the rolls vary significantly, but can be as large as 3' x 5', and weigh as much as 600 lbs.

The primary problem facing the company in this application was operator injury, especially back strains. Back injuries were the leading cause of lost time injury for the company, and at one point were occurring as frequently as once per week. While most rolls are far too big for a single operator to lift, some smaller rolls may only weigh 60 pounds, which are tempting for an operator to move manually in a time saving effort.

The company began looking for a lifting solution that would be able to reduce the number of employee injuries, while at the same time handle the paper rolls without product damage.

"The two options being considered were an up-ender and a crane with a manipulator," said John Frederick of Green Bay Packaging. "The problem with the up-ender was that we couldn't handle the rolls the way we wanted to when loading the skids. The manipulator became important for stacking multiple rolls."

With the manipulator selected for tooling, Green Bay Packaging selected a 4,000 pound capacity Gorbel work station crane, featuring dual girder bridges to support the manipulator. The crane also features tractor drives to make movement along the runways even easier for operators.

The implementation of the new process was very effective, as workers found moving even the heavier loads was easier. The manipulator inserts into the hole of the paper rolls and turns it to the proper position. Though the manipulator itself is quite heavy, the dual girders of the Gorbel workstation crane keep the load completely stable, even when the load is not centered beneath the base of the manipulator. The tractor drives assist the operators movement on the x and y axis so that stopping and starting motion of a heavy load does not strain operators.

Of course, the primary goal the company when putting the system in the area was to reduce injuries. "There's been a huge reduction in workplace injuries," said Frederick. "Keeping our workers safe is our top priority. With this Gorbel workstation crane, there have been no injuries, and that was this project's biggest success."

See this and many more work station crane case studies at www.gorbel.com/solutions/casestudies



SEE VIDEO OF THIS APPLICATION!

See this Gorbel solution in action by scanning the QR code below.



"There's been a huge reduction in workplace injuries."

WORK STATION CRANE COMPONENTS

10 HANGER ASSEMBLIES: CEILING MOUNTED

Each Gorbel® Ceiling Mounted Work Station Bridge Crane is provided with the necessary number of hanger assemblies, based on your application needs.

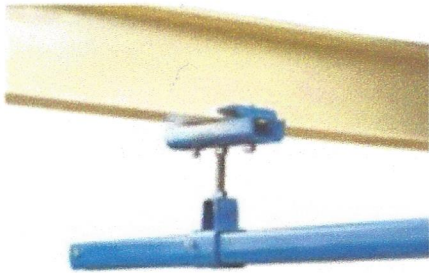

PLAIN STEEL TRACK

Standard hangers for plain steel track, with a 20 inch threaded rod (B7 alloy), are included with each assembly. The threaded rod can be field cut to custom lengths as required. An optional 72 inch rod can also be supplied. Two beam clips are bolted to the upper hanger bracket and are clamped to the supporting structure. The upper hanger brackets are adjustable for flange widths from 1 to 10 inches.

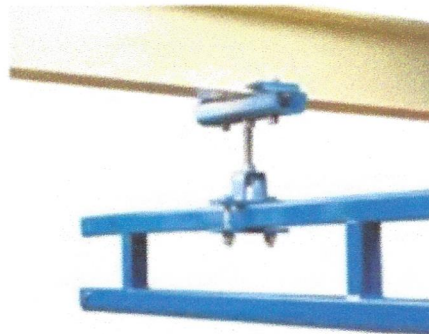

TRUSSED STEEL TRACK

Standard hangers for trussed steel track, with a 20 inch threaded rod (B7 alloy), are included with each assembly. The threaded rod can be field cut to custom lengths as required. An optional 72 inch rod can also be supplied. Two beam clips are bolted to the upper hanger bracket and are clamped to the supporting structure. The upper hanger brackets are adjustable for flange widths from 1 to 10 inches.

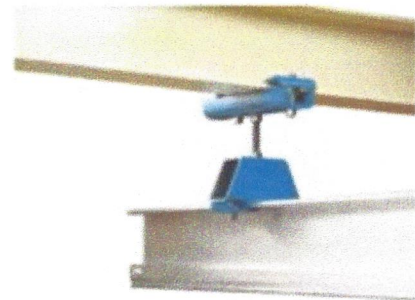

ALUMINUM TRACK

Standard hangers for aluminum track, with a 20 inch threaded rod (B7 alloy), are included with each assembly. The threaded rod can be field cut to custom lengths as required. An optional 72 inch rod can also be supplied. Two beam clips are bolted to the upper hanger bracket and are clamped to the supporting structure. The upper hanger brackets are adjustable for flange widths from 1 to 10 inches.

HANGER ASSEMBLIES: FREE STANDING

Each Gorbel® Free Standing Work Station Bridge Crane is provided with the necessary number of hanger assemblies, based on your application needs.



HANGERS FOR TRUSSED STEEL TRACK

Hangers for steel runways are included with each assembly as shown. The runways are flush mounted under the free standing support assemblies via spine clamp angles, B7 alloy threaded rods, and the appropriate hardware.

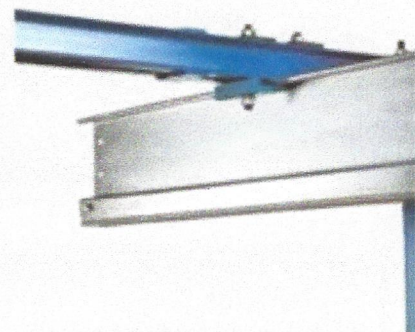

HANGERS FOR ALUMINUM TRACK

Standard hangers for aluminum runways are included with each assembly shown. The runways are flush mounted under the free standing support assemblies via beam clips, B7 alloy threaded rods, and the appropriate hardware.



8121 Saddleback Place
Maineville, OH 45039
Phone: (513) 677-1770
Fax: (866) 313-5501



SWAY BRACE FITTING (NOT SUPPLIED AS STANDARD)

Sway bracing is required on all systems except flush mounted systems to provide for a rigid-mount runway that allows the end truck to move freely. The fittings permit easy sway bracing with 1 inch standard steel pipe (pipe supplied by others). The flange is drilled to accept a 5/8 inch bolt (bolt by others) with two U-bolts (furnished). These optional fittings are not supplied as standard with crane kits.

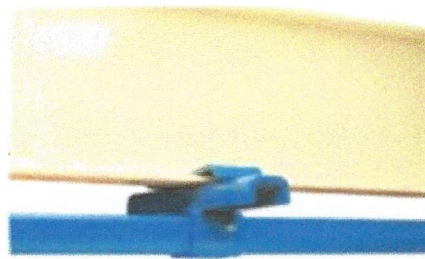

FLUSH MOUNTED HANGERS – PARALLEL MOUNT

An optional ceiling support bracket, with beam clips, can be provided for plain track series that require flush mounting. With this bracket, the track is mounted underneath, parallel to the supporting steel. Two beam clips are bolted to the hanger bracket and are clamped to the supporting structure. When using this style, care should be taken to determine if the bridge has adequate overhead clearance. Note: to order this bracket, the flange width of the supporting structure must be supplied.

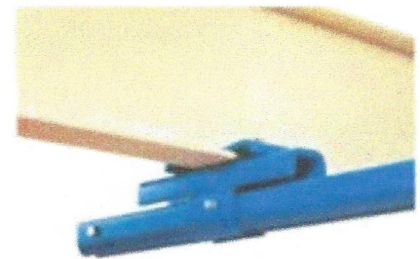

FLUSH MOUNTED HANGERS – PERPENDICULAR MOUNT

An optional ceiling support bracket, with beam clips, can be provided for plain track series that require flush mounting. With this bracket, the track is mounted underneath, perpendicular to the supporting steel. Four beam clips are bolted to the hanger bracket and are clamped to the supporting structure. When using this style, care should be taken to determine if the bridge has adequate overhead clearance. Note: to order this bracket, the flange width of the supporting structure must be supplied.

NEED A LIFTING DEVICE? COMPLETE YOUR ERGONOMIC LIFTING SOLUTIONS WITH GORBEL'S G-FORCE®

If your lifting application requires precision placement or blazing speeds, consider Gorbel's G-Force® Intelligent Lifting Device. The G-Force® uses exclusive patented technology and an industrial processor controlled servo drive system to deliver unmatched lifting precision and speed.

Gorbel's Intelligent Lifting Devices give you the best of both worlds: the responsiveness and flexibility of a human operator plus the power of a machine to maximize productivity while minimizing the risk of injury to the operator. And, they incorporate a range of speeds, making them perfect for quick, repetitive motions and slow, precise placements. The G-Force® is available in capacities to 1320 lbs with speeds to 200 feet per minute. Teachable virtual limits, speed reduction points, and float mode make it the ideal solution for a wide range of lifting applications.



OPTIONS WHEN USING MULTIPLE BRIDGES

What are your options when using multiple bridges? This section addresses the advantages and disadvantages of various multiple bridge system designs.

MIXED CAPACITY SYSTEMS

In mixed capacity systems, each bridge is sized for an individual rated load. Runways, on the other hand, are sized for the combined weight of all loads, so they use a heavier track series than any individual bridge.

Advantages:

- There are no "dead" coverage areas (areas with no bridge coverage) along the length of the system, so each bridge can travel the length of the system. (See mixed capacity system diagram)
- There are limited "dead" coverage areas between bridges, so bridges can be used side-by-side. (Compare mixed capacity system diagram with bridge buffer system diagram)
- Bridges weigh less, making the system more ergonomically friendly.

Disadvantages:

- Mixed capacity systems use larger sized runways, so they may cost more than bridge buffer systems or systems that use intermediate stops.

BRIDGE BUFFER SYSTEMS

In bridge buffer systems, bridges are sized for each individual rated load. Runways are sized for the heaviest individual load, so the runways are the same size as the largest bridge. Bridges are physically separated by wheeled, movable bridge buffers.

Advantages:

- Bridge buffer systems usually cost less than mixed capacity systems because they typically use smaller sized runways.

Disadvantages:

- The bridge buffers take up space (typically half the distance of the support centers), which creates a moving "dead" space between bridges. (See bridge buffer system diagram)

Note: When using two bridges, the dead space equals half the distance between support centers (L1 from the dimensional charts). When adding a third bridge, the dead space occupied by the additional bridge buffers equals the full distance between support centers.

SYSTEMS WITH INTERMEDIATE STOPS

In systems with intermediate stops, bridges are sized for each individual rated load. Runways are sized for the heaviest individual load, so the runways are the same size as the largest bridge. Bridges are physically separated by internal stops or bumpers. Extra hangers usually are required to eliminate overload. (See intermediate stops system diagram.)

Advantages:

- Systems with intermediate stops use smaller runways, therefore typically cost less than mixed capacity systems.
- There are fewer potential "dead" spots in the system. (Compare intermediate stops system diagram with bridge buffer system diagram)

Disadvantages:

- Each bridge on the system can travel only a portion of the length of the system. (See intermediate stops system diagram)
- Systems with intermediate stops may be more difficult to install, as additional ceiling support points must be available to accommodate the additional hangers required to prevent an overload situation.

MIXED CAPACITY SYSTEMS

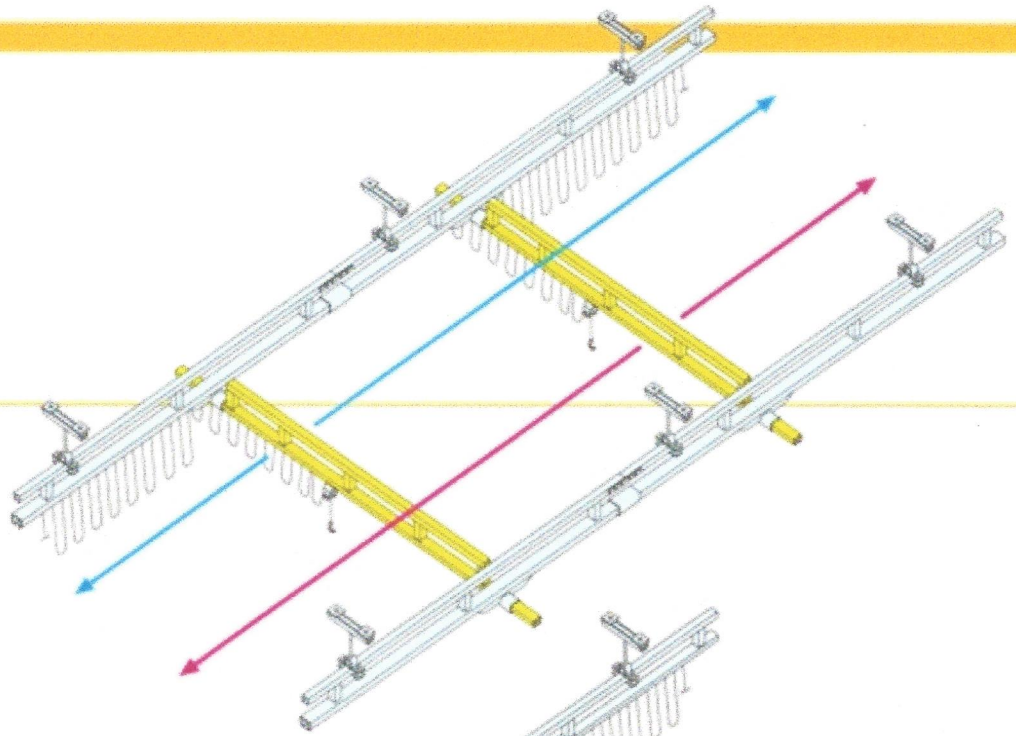

BRIDGE BUFFER SYSTEMS

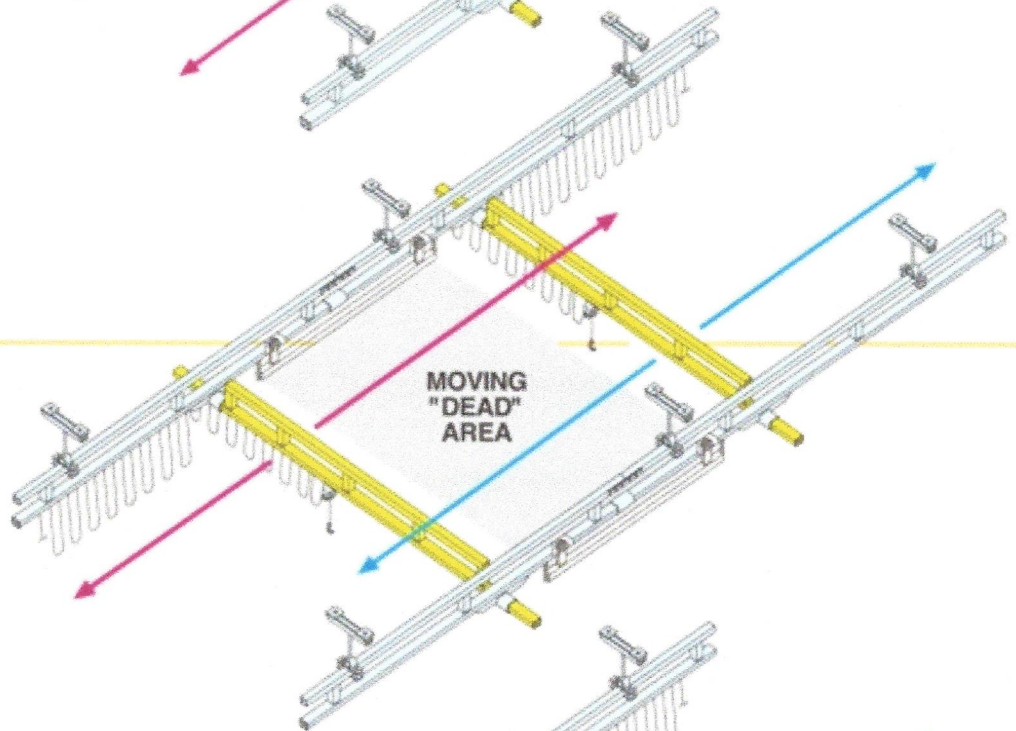

SYSTEMS WITH INTERMEDIATE STOPS

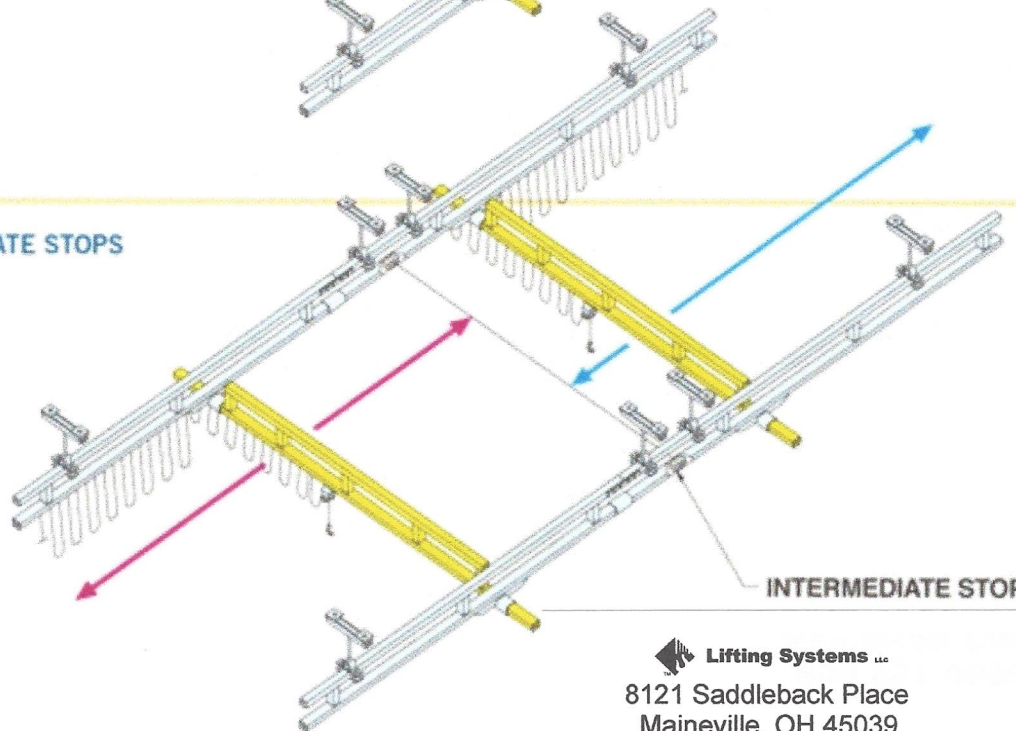

 **Lifting Systems** ..
8121 Saddleback Place
Maineville, OH 45039
Phone: (513) 677-1770
Fax: (866) 313-5501

CUSTOM CRANE CONFIGURATIONS

ALUMINUM WORK STATION BRIDGE CRANES

For demanding, rapid, repetitive handling applications, the Aluminum Work Station Bridge Crane is the best ergonomic solution on the market. It is also ideal for facilities with structural limitations and challenging environments. This crane reduces bridge dead weight by up to 40%. In addition, our unique aluminum design, using high strength aluminum alloy, results in an unparalleled combination of spans, capacities, and ease of movement.

Features:

- A modular design that lets you use aluminum bridges on steel runways to provide cost effective solutions that are easy to install, expand, and field customize
- A unique track design that facilitates installation and provides precise track alignment
- Up to 40% lighter in weight than equivalent steel track systems
- Special anti-binding end trucks for free and easy movement



Aluminum Work Station Bridge Cranes

CANTILEVERED SUPPORTS

Increasing the effectiveness of large cranes, these support columns are used where material is delivered or removed from work cells by large overhead cranes or in applications where doors swing into the area.

Cantilevered supports can handle loads up to 4000 lbs. and are the answer any time the normal header of a free standing support assembly interferes with an operator's activity in the work cell.



Cantilevered Supports



8121 Saddleback Place
Maineville, OH 45039
Phone: (513) 677-1770
Fax: (866) 313-5501

INTERLOCK/TRANSFERS

Gorbel's interlock/transfer cranes allow loads to be transferred from a bridge crane to monorail spurs and vice-versa. The interlock/transfer cranes are fast and easy to use. The bridge only engages the interlock when the operator actuates it so they do not impede the workers when not in use. The interlock is designed so the trolley stops will lock and not allow the passage of the hoist trolley until the bridge and monorail are in alignment and mechanically linked.

The bridge and monorail spur cannot be separated until the trolley stops are fully closed and in the locked position. They can be easily adapted to an existing Gorbel® Work Station Bridge Crane.

TRACTOR DRIVES FOR STEEL TRACK

Gorbel's tractor drives provide motorized movement on new or existing enclosed track Gorbel® Work Station Bridge Cranes and Monorails. The drives are designed for indoor use and are available for steel track. Applications for tractor drives include work areas where the operator cannot stand next to the load to move it by hand or during operations with high cycle times that require frequent lifting of heavy, awkwardly shaped loads.

OFFSET LOAD/MANIPULATOR PLATFORM

Gorbel's Offset Load/Manipulator Platform is designed to support almost any rigid or base plate mounted lifting device and manipulator. One platform can be used in multiple work cells or be moved anywhere within the crane coverage area. This design reduces skewing and binding of the carriers for smooth, consistent movement of your manipulators and tooling on Gorbel's rails.

TELESCOPING BRIDGES

Gorbel's telescoping bridge allows for extension outside the normal reach of a Gorbel® Work Station Bridge Crane. The telescoping bridge is designed for effortless movement and easy installation. The bridge features an adjustable leveling device and anti-kickup wheels to prevent binding of the bridge when telescoped. Applications for a telescoping bridge include reaching into adjacent work cells to transfer material, loading parts into a machine opening, and reaching out beyond a building column or under mezzanines.



Interlock/Transfers

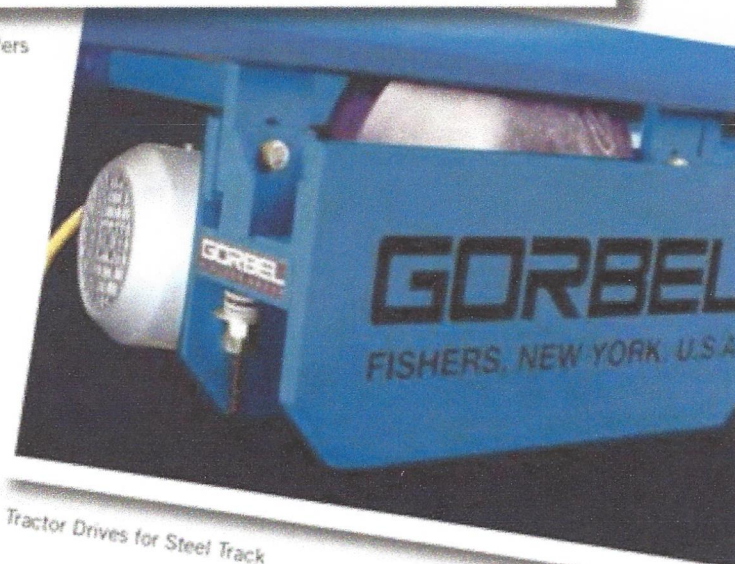

Tractor Drives for Steel Track

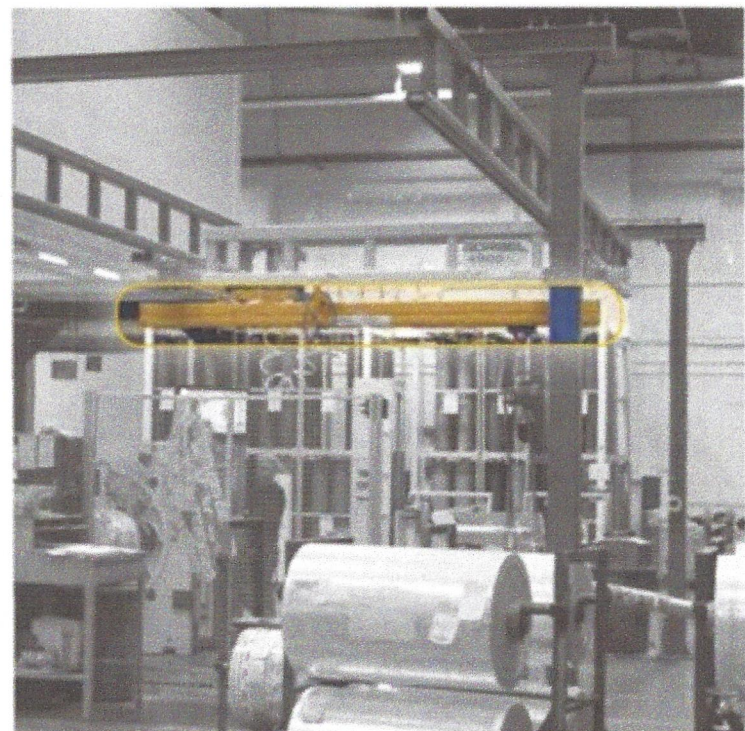

Telescoping Bridges

CUSTOM CRANE CONFIGURATIONS

NESTED TROLLEY

Ideal for low headroom applications, our nested trolleys enable you to raise the height of the hoist and increase the available lift. A nested trolley consists of a dual girder bridge with a box shaped assembly (a "nest") that travels between the bridge girders. With this custom designed "nest", the hoist is mounted up inside the bridge structure, which allows you to get back the lift typically taken up by the body of the hoist.

MAINTENANCE GATES

Gorbel's Maintenance Gates allow access points in the middle of long systems. This eliminates the need to remove end bridges when inspecting or servicing individual bridges in the middle of long systems. They also make it easier to install bridges on systems that have little or no space at the end of the runways.

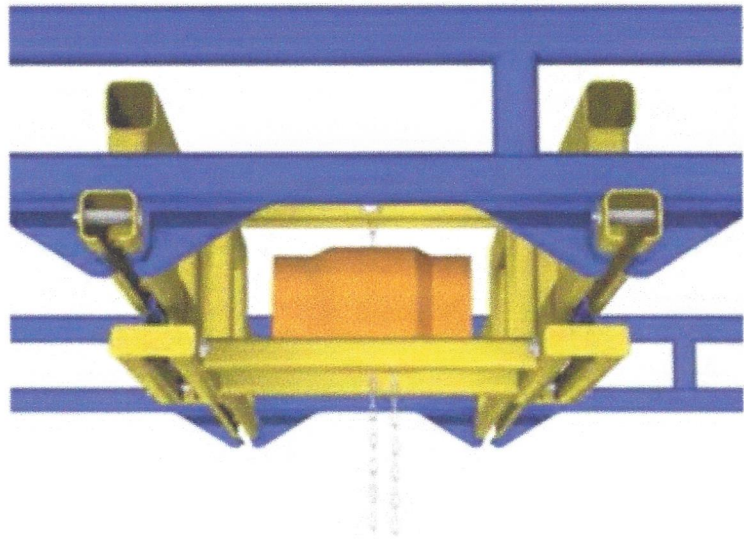

Nested Trolley

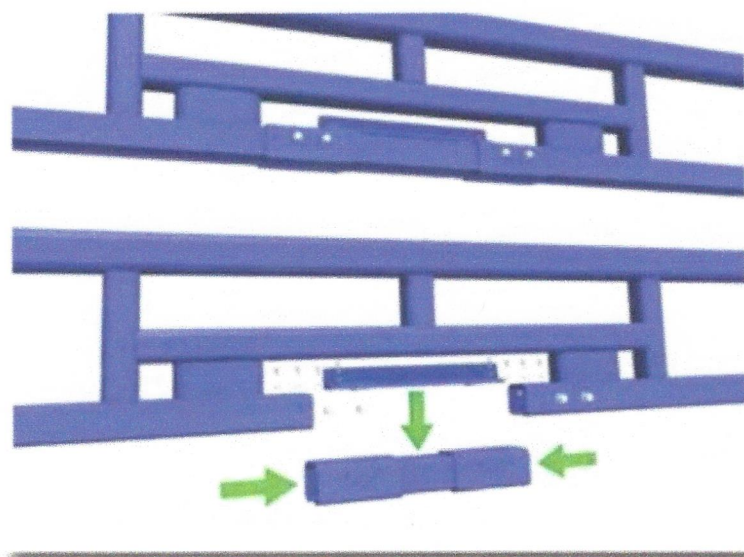

Maintenance Gates



8121 Saddleback Place
Maineville, OH 45039
Phone: (513) 677-1770
Fax: (866) 313-5501

MAINTENANCE GATES SOLVE BIG PROBLEM FOR SMALL BUSINESS

"What used to take three people 45 minutes is now a one person job that only takes a minute or two."

As the owner of a tool & machine shop, Rodney Fuller was running into some large problems. His customer base was growing, and the parts he was running through his CNC lathes and milling machines were becoming larger and more diverse.

"A lot of the parts were smaller, maybe 65 pounds," said Fuller. "But now we're getting parts that are 12-inches in diameter, and they weigh about 225 pounds."

The larger parts first created the problem of how to handle and load them into the machines. Without an ideal solution, it began to cut into the company's productivity.

"I was using an engine hoist, a cherry picker, to load them," he said. "That just wasn't working. It would take three of us to maneuver it and load it. Sometimes I'd literally be standing inside the machine positioning it while two other guys were moving the load in. It didn't take long to realize that I was taking safety risks and we're taking additional people away from what they're working on to help load one machine. I knew I needed to change what we were doing."

With experience in metal fabrication, Fuller's first thought was to build a structural I-beam crane himself. However, with the two CNC machines already in place in a very narrow workspace with limited headroom, every inch would be critical.

The Gorbel Solution: Fuller decided to go with a 500 pound capacity Gorbel work station bridge crane. No stranger to Gorbel, he knew the system would be easier to move than an I-beam crane. What made the decision easy was the way the system would maximize the space available. The system featured custom header to column connections, which brought the 16 foot, 11 inch runways right to the edge of the room, allowing wall-to-wall coverage. This tight fit was made possible by installing maintenance gates along the system's runways, which allow a section of the track to be temporarily removed so the bridge can be installed.

"The system has exceeded my expectations," said Fuller. "What used to take three people 45 minutes is now a one person job that only takes a minute or two. Our productivity has improved significantly." Asked if he has any regrets in choosing the Gorbel system rather than building one himself, Fuller had no doubt that he made the right choice. "This has made my life so much easier. The safety is...incredible. It's been well worth the money."

See this and many more work station crane case studies at www.gorbel.com/solutions/casestudies



SEE VIDEO OF THIS APPLICATION!

See this Gorbel solution in action by scanning the QR code below.



"The system has exceeded my expectations."

INSTALLATION GUIDELINES

Capacity	Series	Weight per Foot	Max. L1	Max. L2	Max. L5	Max. L9
250#	GLC	2.53 #	6'	8"	18"	18"
	GLCS	4.92 #	20'	48"	18"	48"
	AL	4.05 #	20'	30"	48"	48"
	GLCSL	8.43 #	25'	48"	18"	48"
500#	GLC	4.15 #	6'	8"	24"	20"
	GLCS	7.44 #	20'	48"	24"	48"
	AL	4.87 #	20'	30"	48"	48"
	GLCSL	10.71 #	25'	48"	24"	48"
	GLCSLX	11.01 #	30'	48"	24"	48"
1000#	GLC	6.22 #	6'	8"	24"	20"
	GLCS	12.25 #	20'	48"	24"	48"
	AL	8.36 #	20'	30"	48"	48"
	GLCSL	14.08 #	25'	48"	24"	48"
	GLCSLX	17.47 #	30'	48"	24"	48"
2000#	GLC	9.12 #	6'	8"	24"	24"
	GLCS	16.89 #	20'	48"	24"	48"
	AL	10.01 #	20'	30"	48"	48"
	GLCSL	19.36 #	25'	48"	24"	48"
	GLCSLX	20.13 #	30'	48"	24"	48"
4000#	GLC	9.12 #	4'	8"	24"	24"
	GLCS	20.68 #	20'	48"	24"	48"
	GLCSL	26.21 #	25'	48"	24"	48"
	GLCSLX	28.22 #	30'	48"	24"	48"

NOTE: Same guidelines apply for Monorails (GLMS, GLMSL, GLMSLX, ALM), with the exception of the "L5" dimension (not applicable).

NOTE: Typical L5 is 12". Max. L5 may not be achievable (dependent on truss design of bridge.)

NOTE: Anti-kick-up end trucks* are required for the following:

- bridges with \square 8' span (L4) and a bridge cantilever (L5) \square 12"
- bridges with $<$ 10' span (L4) and a bridge cantilever (L5) $>$ 15"
- bridges with $<$ 15' span (L4) and a bridge cantilever (L5) $>$ 18"

*Anti-kick-up end trucks are not included as part of the standard crane kits.

**2000# @ 10' span (L4) and bridge cantilever (L5) 15" need anti-kick-up end trucks.

Consult Gorbet® factory for information on bridges greater than 15' span (L4).

L1 = MAXIMUM HANGER CENTERLINE

Maximum Hanger Centerline is considered from the center of a hanger to the center of the neighboring hanger.

L2 = SPLICE JOINT CENTERLINE TO HANGER CENTERLINE

Splice Joint Centerline to Hanger Centerline is considered from center of a splice joint to the center of the nearest hanger.

L5 = BRIDGE CANTILEVER**

Bridge Cantilever is considered from the centerline of the runway to the end of the bridge.

L9 = MAXIMUM RUNWAY CANTILEVER

Runway Cantilever is considered from the center of the end hanger to the end of the runway.

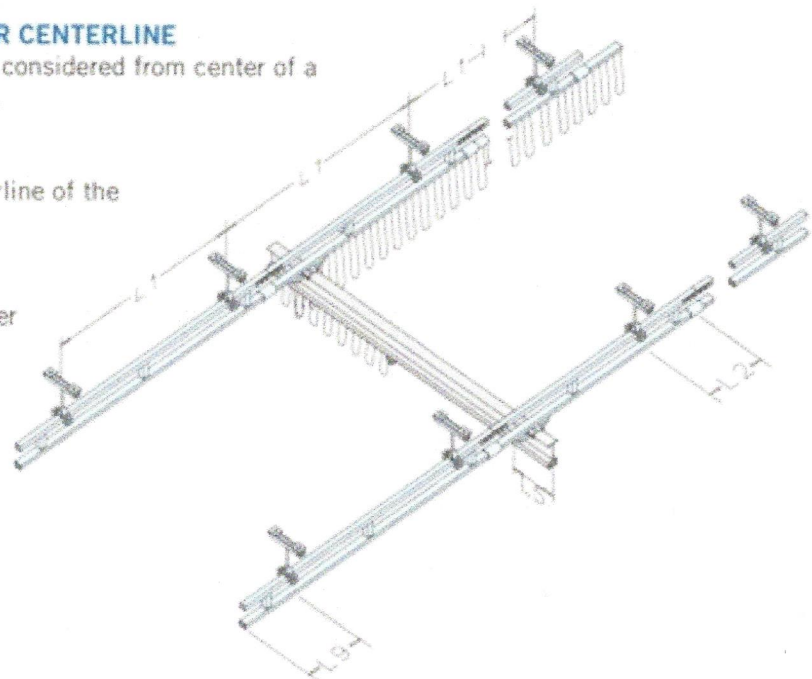

8121 Saddleback Place
Maineville, OH 45039
Phone: (513) 677-1770
Fax: (866) 313-5501

STANDARD BRIDGE CANTILEVER

Bridge Series	Bridge Overall Length					
	Steel					
	<=23'	28'	29'	33'	34'	
250	12"	18"	na	na	na	
500	12"	18"	24"	18"	24"	
1000	12"	18"	24"	18"	24"	
2000	12"	18"	24"	18"	24"	
4000	15"	18"	24"	18"	24"	

Bridge Series	Bridge Overall Length					
	Aluminum					
	<=20'	23'	28'	29'	33'	34'
250	12"	18"	18"	na	na	na
500	12"	18"	18"	24"	18"	24"
1000	12"	18"	18"	24"	18"	24"
2000	12"	18"	18"	24"	18"	24"
4000	12"	18"	18"	24"	18"	24"

SPLICE JOINTS FOR RUNWAYS

Extending the length of your work station crane is easy with splice joints for both steel and aluminum track.

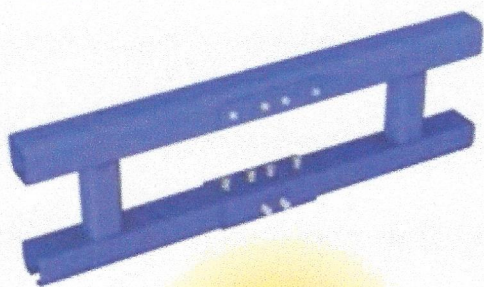

SPLICE JOINTS FOR STEEL TRACK

A splice joint is used to join track sections together and enable the installer to quickly and properly align the joined sections of track. Adjusting bolts are provided on the splice joint for leveling and aligning.

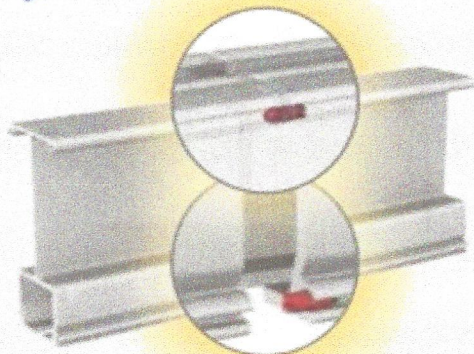

SPLICE JOINTS FOR ALUMINUM TRACK (250 AND 500 ONLY)

Patented splice joints for aluminum track allow for precision alignment. The aluminum track is extruded with four patented alignment slots. Four precision-ground pins are provided to accurately align runway sections, which provides for a smoother transition of wheels over the splice joint than is possible with bolted connections. In addition, clamp fasteners attach to the vertical web of the track to pull the track together and keep it from separating.

OVERVIEW BROCHURE



FOR MORE INFORMATION

Your authorized Gorbel dealer can give you more information on what makes Gorbel's Ergonomic Work Station Cranes and other material handling products "A Class Above."

BRIDGE CRANES



CLEVELAND TRAMRAIL



ERGONOMIC STUDY

ERGONOMIC LIFTING



G-FORCE® & EASY ARM®



ERGONOMIC STUDY

JIB CRANES



JIB CRANES



GANTRY CRANES

SPECIALTY PRODUCTS



TOOL SUPPORT SOLUTIONS



FALL ARREST



TELESCOPING

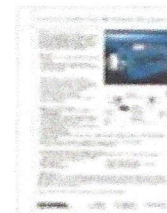

INTERLOCK/TRANSFER



Gorbel crane designs have been audited by an independent third party Professional Engineer and meet or exceed the requirements to be MMA Certified in accordance with the terms of the Material Handling Industry of America.

CRANES

GORBEL
A CLASS ABOVE
www.gorbel.com

 **Lifting Systems** LLC
8121 Saddleback Place
Maineville, OH 45039
Phone: (513) 677-1770
Fax: (866) 313-5501

